

1

2

3

4

5

6

7

8

CHANGE No	REV	DESCRIPTION	DRAWN	DATE
	01	ORIGINAL	AM	07-10-2022

A

B

C

D

E

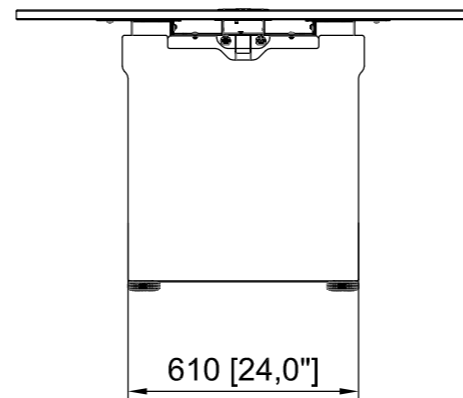
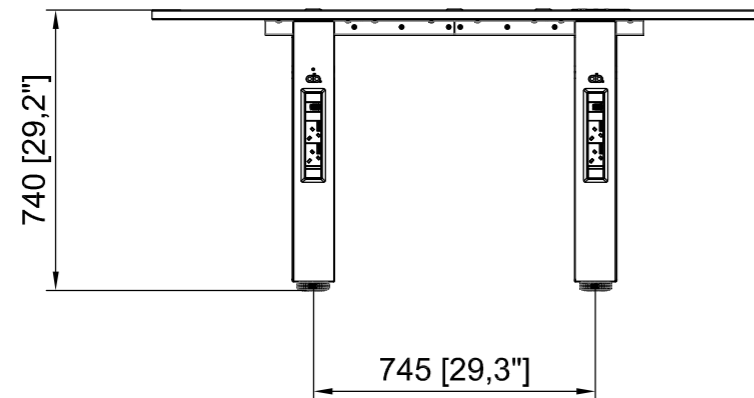
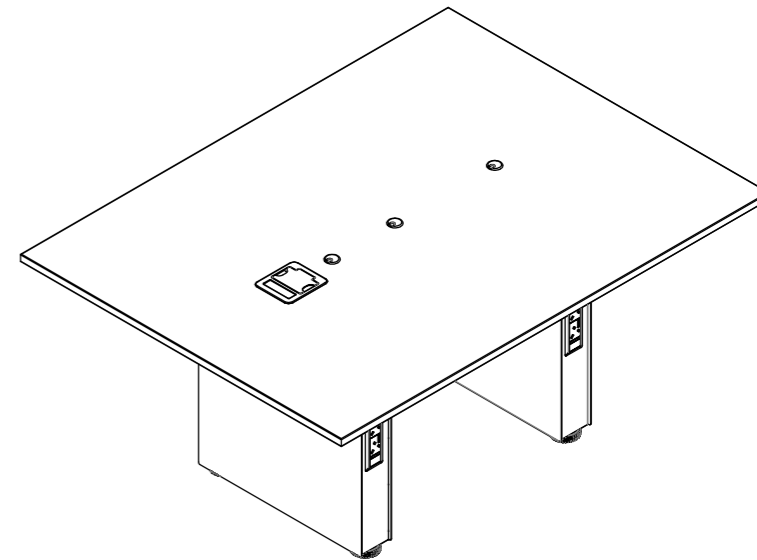
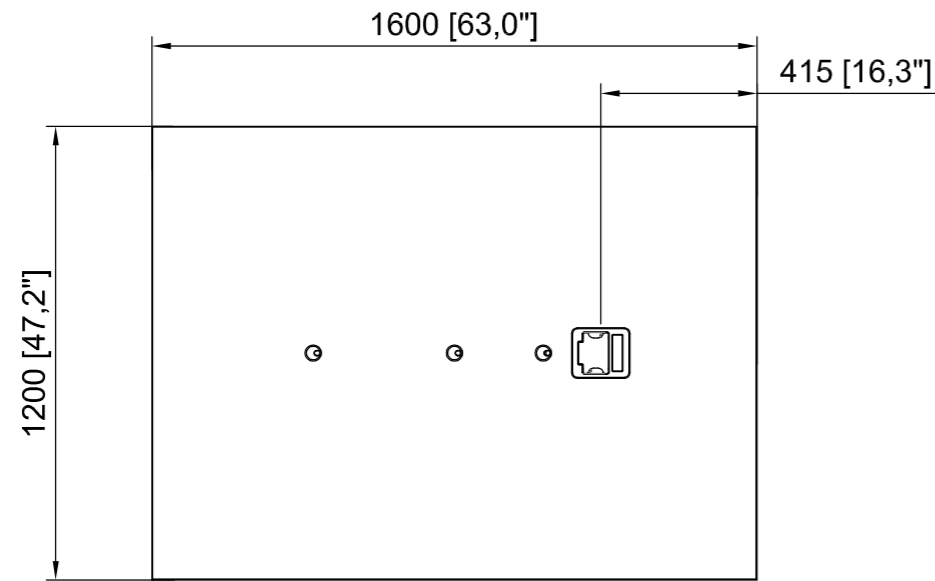

THIS DOCUMENT CONTAINS CONFIDENTIAL INFORMATION. ALL ASPECTS OF ITS CONTENTS ARE PROTECTED BY COPYRIGHT LAW AND MAY NOT BE REPRODUCED IN ANY MANNER, OR FOR ANY PURPOSE, EXCEPT BY WRITTEN PERMISSION OF ASHTON BENTLEY COLLABORATION SPACES LTD, THE COPYRIGHT HOLDER.

THE ITEMS DETAILED IN THIS DRAWING ARE PART OF AN ASHTON BENTLEY PRODUCT WHICH IS PROTECTED UNDER UK PATENT NO. GB2502100

DRAWN BY: A MESTRE
DATE: 07-10-2022

APPROVED BY: J ROWE
DATE: 07-10-2022

THIRD ANGLE PROJECTION:



ASHTON BENTLEY COLLABORATION SPACES LTD.
23 SCHOONER PARK, SCHOONER COURT, CROSSWAYS BUSINESS PARK,
DARTFORD, KENT, DA2 6NW UNITED KINGDOM

TITLE:
RT5 Rectangular 5 Seat Table

DRAWING NUMBER:
740-00216

DRAWING SIZE: A3
DIMENSIONS IN: MM [INCHES]
SCALE: 1:20
SHEET: 1 OF 1
REV: 01